



4-100HE

Carriers

For 5-8 ton excavators
Or 2-5 ton loaders.

Hydraulics

Flow 90 l/m
Pressure 200 bar

Weight

560 Kg

Capacity

0.35m³

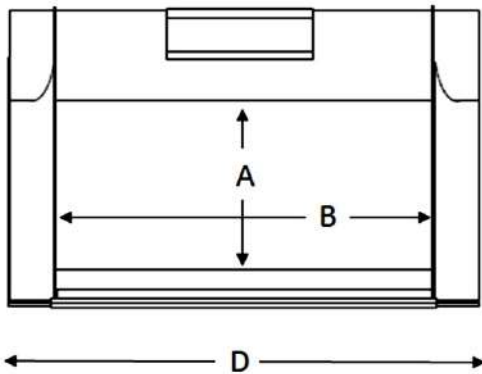

Screening area

615 mm x 1000 mm

Dimensions (mm)

A 615 B 1000
C 570 D 1350
E 820 F 880

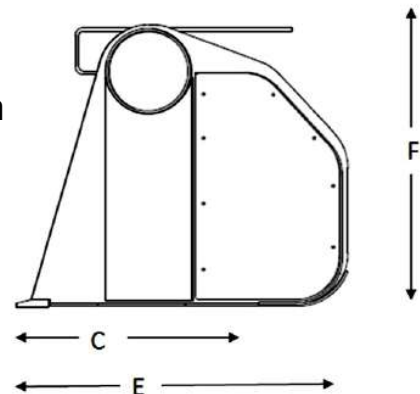

Fast efficient screening systems



True compact screening

Low maintenance bucket

Poly stars which screen without crushing

Large screening area to maximise output